

1.0AMP ULTRA FAST SURFACE MOUNT RECTIFIERS

REVERSE VOLTAGE 50 TO 600 VOLTS

DO - 214AC(SMA)

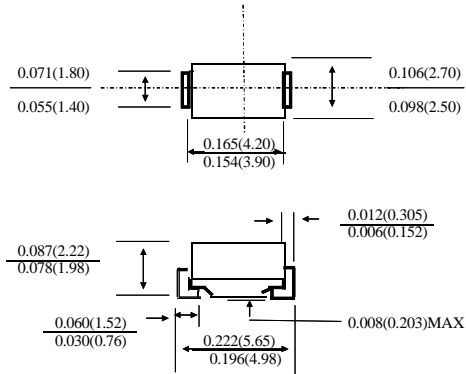

inch (mm)

FEATURES

- . Low cost
- . Diffused junction
- . Low Leakage
- . Low forward voltage drop
- . High current capability
- . Easily cleaned with Freon. Alcohol. Isopropanol and similar solvents
- . The plastic material carries U/L recognition 94V-0

MECHANICAL DATA

- . Case: JEDEC DO - 214AC. molded plastic body
- . Terminals: Solder plated. Solderable per MIL - STD - 750. Method 2026
- . Polarity: Color band denotes cathode
- . Weight: 0.075 grams
- . Mounting position: Any

MAXIMUM RATINGS AND ELECTRICAL CHARACTERISTICS

Ratings at 25 °C ambient temperature unless otherwise specified.

Single phase. half wave. 60HZ. resistive or inductive load. For capacitive load. derate current by 20 %

	SYMBOL	ES1A	ES1B	ES1C	ES1D	ES1E	ES1G	ES1J	UNITS
Maximum Recurrent Peak Reverse Voltage	V _{RRM}	50	100	150	200	300	400	600	V
Maximum RMS Voltage	V _{RMS}	35	70	105	140	210	280	420	V
Maximum DC Blocking Voltage	V _{DC}	50	100	150	200	300	400	600	V
Maximum Average Forward Rectified Current at T _L = 110°C	I <sub(av)< sub=""></sub(av)<>	1.0							A
Peak Forward Surge Current 8.3ms Single half-sine-wave superimposed on rated T _j = 125°C	I _{FSM}	30							A
Maximum Forward Voltage at 1.0A DC	V _F	0.95				1.25			V
Maximum Reverse Current T _A = 25°C at Rated DC Blocking Voltage T _A = 100°C	I _R	5.0				50			μ A
Maximum reverse recovery time (Note 1)	t _{rr}	35							ns
Typical Junction Capacitance (Note 2)	C _j	17							pF
Typical Thermal Resistance (Note 3)	R _{QJA}	60							°C/W
Operating Junction Temperature Range	T _j	- 55 to 150							°C
Storage Temperature Range	T _{STG}	- 55 to 150							°C

- NOTE:
1. Reverse recovery condition I_F=0.5A I_R=1.0A I_{rr}=0.25A.
 2. Measured at 1.0MHz and applied reverse voltage of 4.0V DC.
 3. Thermal Resistance Junction to Ambient.

FIG. 1 -- TYPICAL FORWARD CHARACTERISTIC

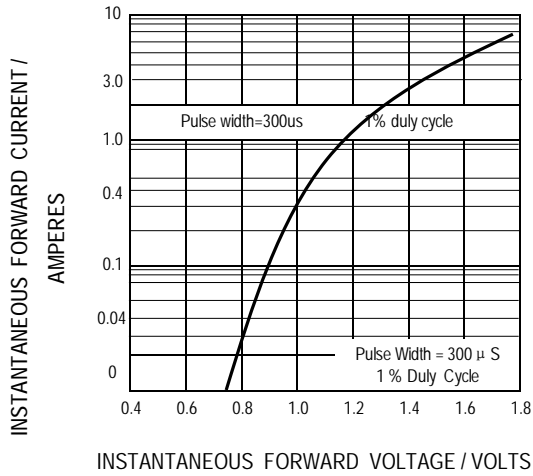

FIG. 2 -- TYPICAL JUNCTION CAPACITANCE

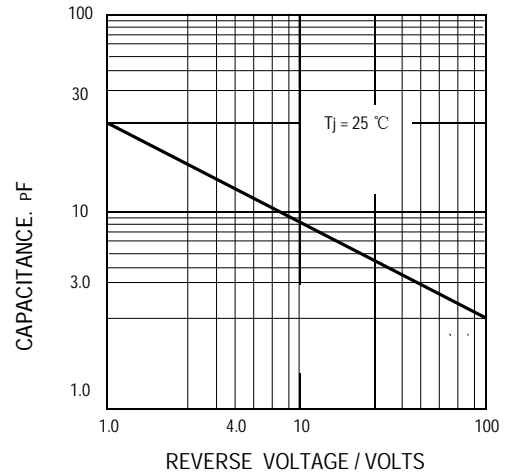

FIG. 3 -- FORWARD CURRENT DERATING CURVE

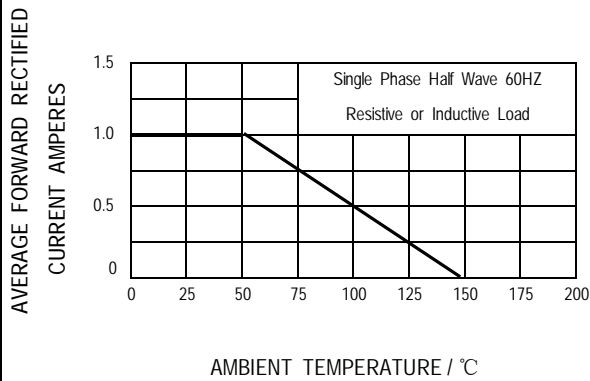

FIG. 4 -- PEAK FORWARD SURGE CURRENT

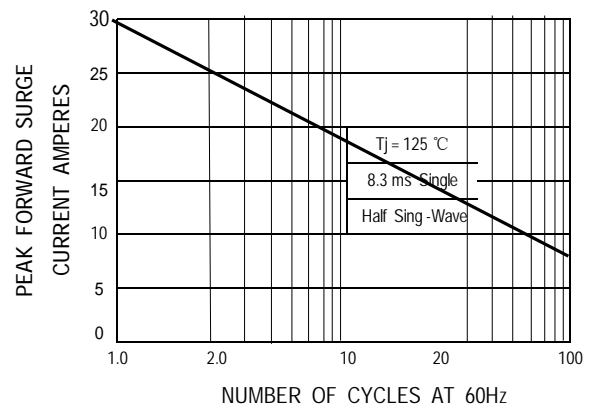
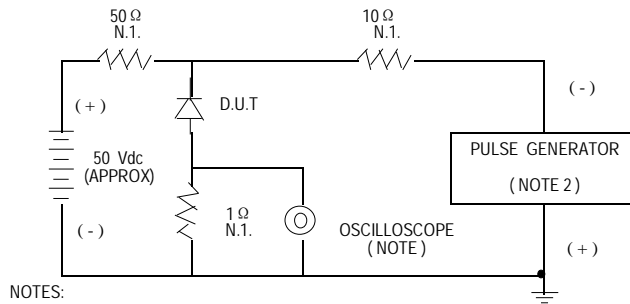
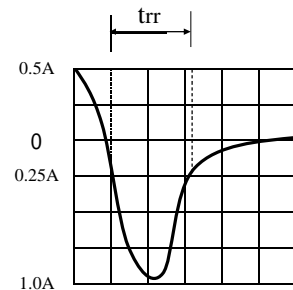

FIG. 5 -- TEST CIRCUIT DIAGRAM AND REVERSE RECOVERY TIME CHARACTERISTIC



NOTES:

1. RISE TIME = 7n SEC MAX. INPUT IMPEDANCE = 1 MEGOHM. 22PF
2. RISE TIME = 10n SEC MAX. SOURCE IMPEDANCE = 50 OHM.



SET TIME BASE FOR 15 ns/cm